

CORNELL PUMP LLC

Z-SERIES

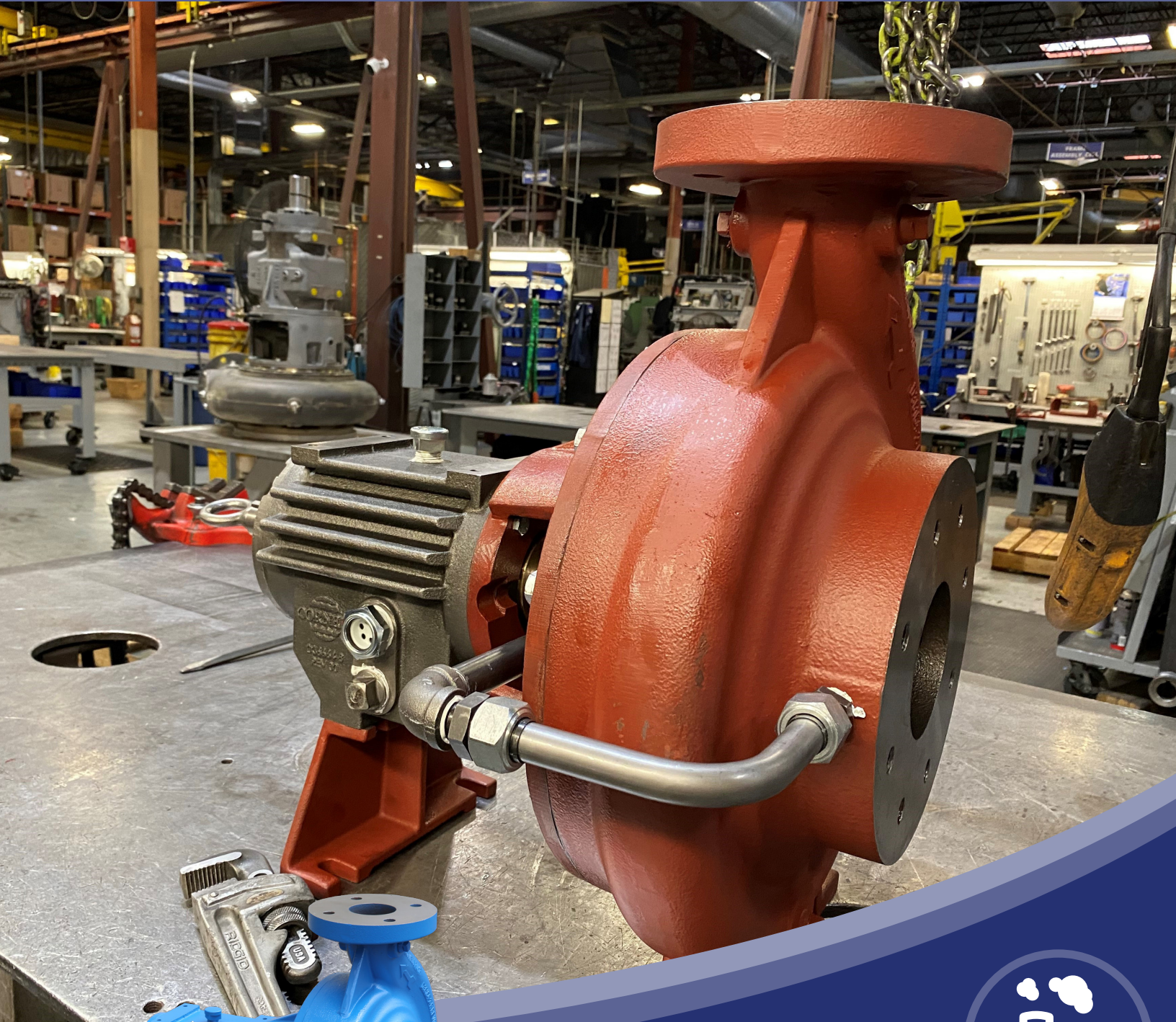

Z-SERIES MARKETS

Z-SERIES ADDRESSES VARIOUS MARKET NEEDS FROM INDUSTRIAL TO MUNICIPAL, AGRICULTURAL, AND BEYOND.



INDUSTRIAL PROCESS

Z-Series centrifugal pumps' robust build and higher efficiencies position the series to offer better results than standard ANSI pumps. Easy access to parts and Cornell quality since 1946 make the Z-Series an easy choice for these applications:



CHEMICAL PROCESSING



FOOD PROCESSING



GRAIN/MILLING



HOT OIL



PAPER/PULP



POWER GENERATION

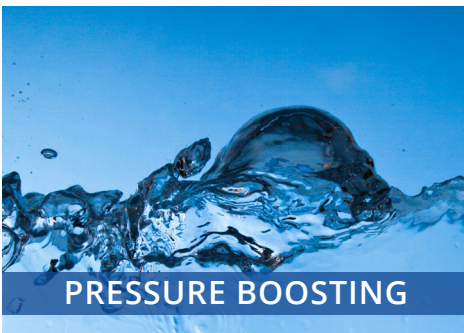

PRESSURE BOOSTING



TEXTILES



WASTEWATER

AGRICULTURAL, MINING, AND RENTAL

Cornell is active across many different markets, and the Z-Series is suitable for irrigation, drip system systems, booster pumps, spray down, press, and many other applications.

Z-SERIES MARKETS



MUNICIPAL PURPOSES

Cornell has been involved in municipal applications since designing hydro turbines for Northwest electrification projects in the early 1950s. Our design knowledge and application expertise make the Z-Series uniquely suited to tackle water and wastewater applications such as:



*NSF certification forthcoming

Please note: The applications listed are typical and not meant to be inclusive. The Z-Series is applicable for many applications; contact your Cornell distributor to make the best selection.

Z-SERIES PUMPS

CORNELL PUMP DECADES OF PROGRESS

Cornell Pump has been designing and manufacturing pumps near Portland, Oregon, since 1946. We're a trusted manufacturer of durable and high-efficiency pumps, delivering unparalleled value to our customers. Our Z-Series pumps are engineered to meet the demanding requirements of industrial, municipal, mining, and other applications, providing unparalleled reliability, compatibility, and interchangeability. With a broad range of pump models and configurations, we can easily integrate our pumps into your existing systems. Moreover, we support custom system designs to meet your specific needs. Our team of technical and engineering experts is among the best in the industry and can provide innovative pump solutions of the highest quality.



PUMPS DESIGNED FOR SPECIFIC JOBS

Our team of expert engineers designs pumps to meet the varying demands of industry applications, such as solids handling, slurry, and head requirements.

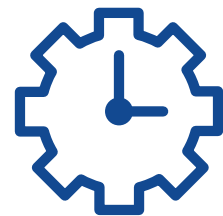

OUTSTANDING EFFICIENCIES

We put our experience and knowledge to work to produce tested designs with some of the highest efficiencies of any pumps on the market.

Z-SERIES PUMPS

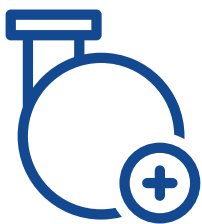

A WIDE VARIETY OF SIZES AND CONFIGURATIONS

Models range in size from 1" to 24" (Z-Series runs 2" to 8"), and a range of configuration options are available for each model – including frame and engine mount options and Cornell features like Run-Dry™ and Redi-Prime®.



ROBUST CONSTRUCTION

Cornell pumps are built using superior materials selected for suitability to each pump's intended application. Heavier casting walls, thicker shafts, and fully machined impellers make Cornell pumps more rugged and durable than other pumps.



QUALITY ASSURANCE

Cornell Pump proudly maintains its ISO 9001:2015 certification, which validates that Cornell complies with all necessary processes to meet customer requirements. The elements associated with ISO 9001:2015 certification include contract review, design and development, production, purchasing, quality control, and service.

Z-SERIES COMPONENTS



PATENTED CYCLOSEAL DESIGN



ANSI COMPATIBILITY



MATERIALS OF CONSTRUCTION



EFFICIENT IMPELLER



CORNELL BEARING FRAME



DURABLE VOLUTE



CARTRIDGE SEAL/SEAL FLEXIBILITY



HIGH-QUALITY MOTOR



OVERSIZED SHAFT



CORNELL Co-Pilot™ MONITORING SYSTEM



MULTIPLE SIZE OPTIONS



INDUSTRY LEADING HYDRAULICS



ROBUST BEARINGS



Z-SERIES FEATURES

ANSI COMPATIBILITY

Easily placed or replaced into standard piping and base mount.

CENTERLINE CONSTRUCTION

Conforms to industry standard design.

FRAME MOUNTED, ENGINE MOUNTED OR CLOSE COUPLED

Multiple mounting options to best suit users' needs.

DUCTILE IRON OR CD4MCU STANDARD DESIGN

Significantly stronger and more corrosion-resistant than many other manufacturers' cast iron ANSI pumps, The Z-Series builds on its robust reliability from cast-on-up

ENCLOSED IMPELLER

Increasing efficiency with enclosed impeller.

OVERSIZED OIL LUBED BEARINGS

Oversized bearings better dissipate heat and prolong life, while oil is standard in ANSI configurations.

BEARING FRAME ISOLATORS

Protects against contamination ingress and lubrication loss, helping significantly increase the longevity and reliability of Z-Series.

TYPE 1 SINGLE OR CARTRIDGE SINGLE SEALS STANDARD

Multiple sealing options allow maximum flexibility across applications.

CASINGS

Thick wall casings exceed industry standards to prolong life.

HIGH STRENGTH SHAFT

Cornell's oversize shafts help with deflection and wear.

REDI-PRIME/ RUNDRY™ CAPABLE

Cornell's patented Redi-Prime® system allows for unattended priming and re-priming. At the same time, the RunDry™ option enables the pump to survive if it were to accidentally run without liquid media in the pump for some time.

HYDRAULIC BALANCE LINE

Cornell's feature makes the pump look unique—but more importantly, it helps reduce axial thrust without having to drill efficiency-sapping holes in the impeller.

CORNELL CO-PILOT™ PUMP MONITOR READY

The industry-leading rotating equipment monitor is now a standard.

QUALITY

Designed, manufactured, tested, and sold in the U.S.A.

DELIVERY

Pumps and parts are available for quick shipment through a reliable network of more than 1,200 distributors.

WARRANTY

With a two-year warranty on parts and workmanship standards, Cornell pumps have fewer defects and issues than other pump manufacturers

Z-SERIES EFFICIENCIES

EFFICIENCY AND QUALITY MATTERS

When considering purchasing a pump, it is crucial to remember that the initial price is only a small fraction of the total cost of operating the pump throughout its lifetime. The purchase price typically accounts for five to seven percent of the total cost. The remaining cost comprises maintenance expenses, contributing to about 10 percent of the pump's lifetime cost, and energy expenses, which can make up as much as 85 percent of the total cost. However, Cornell's highly efficient pumps can help you save a significant amount each month, which can lower the overall lifetime cost of the pump and help you avoid maintenance issues in the long run.

ESTIMATING LIFETIME COST

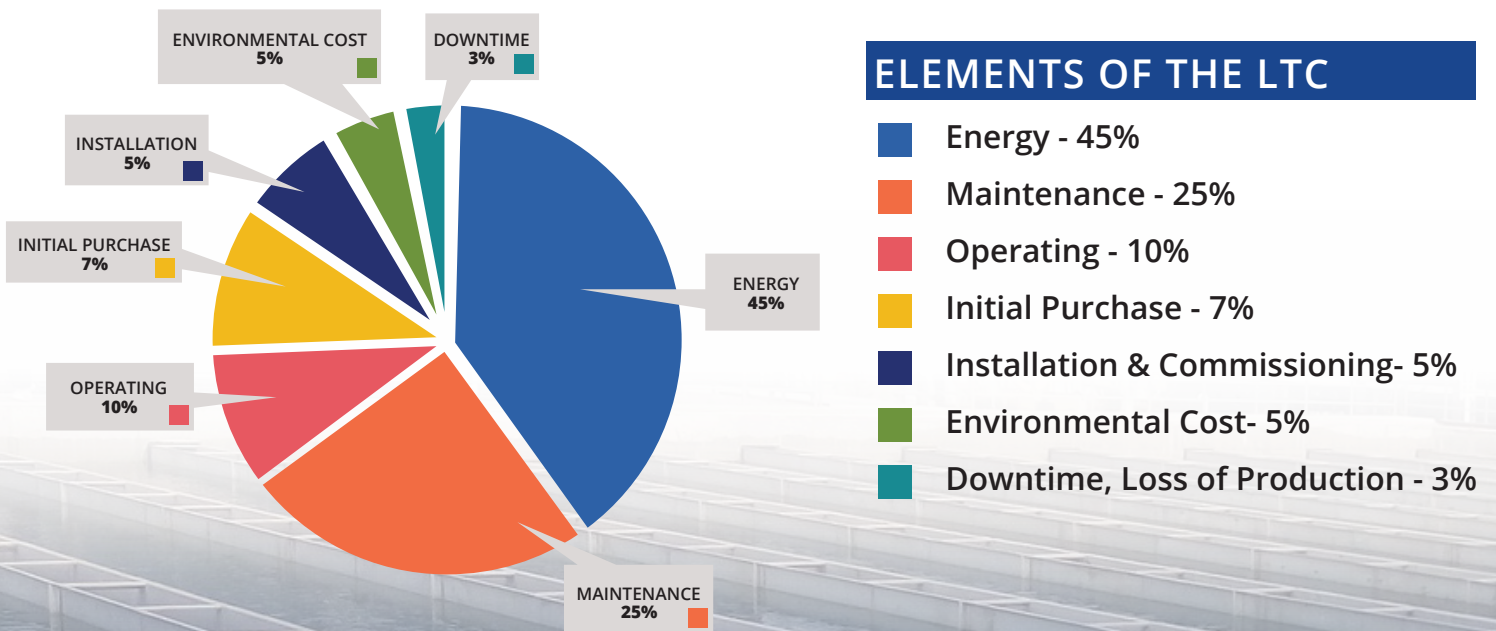

Z-SERIES CARTRIDGE SEALS

Z-SERIES CARTRIDGE SEALS

The Z-Series pumps have highly efficient and adaptable cartridge seals, providing the best possible sealing solutions for harsh operating environments. These seals are incredibly easy to install and service, ensuring minimized downtime and maximizing productivity. Their flexibility and reliability can be used across a range of pump models, delivering consistent and optimal performance even in the most challenging conditions. So, whether you need to move abrasive slurry or corrosive chemicals, the Z-Series pumps, with their superior cartridge seals, have you covered. Here is a list of key advantages:

- Thermal management for improving heat conduction
- Significant torque capabilities versus component mechanical seals
- Self-alignment
- Industry-standard design
- Technician familiarity
- Quick installation
- Visible connection ports
- Galling resistance
- Numerous materials of construction available

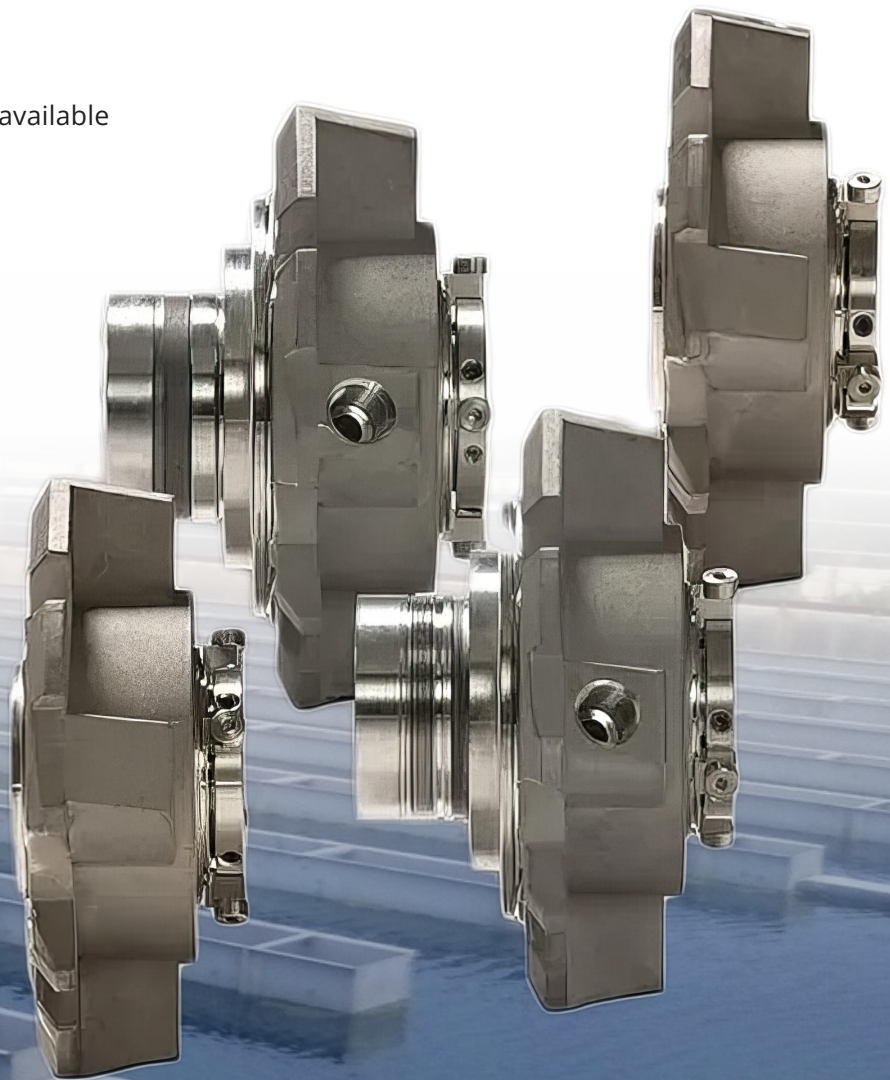

Z-SERIES CURVES

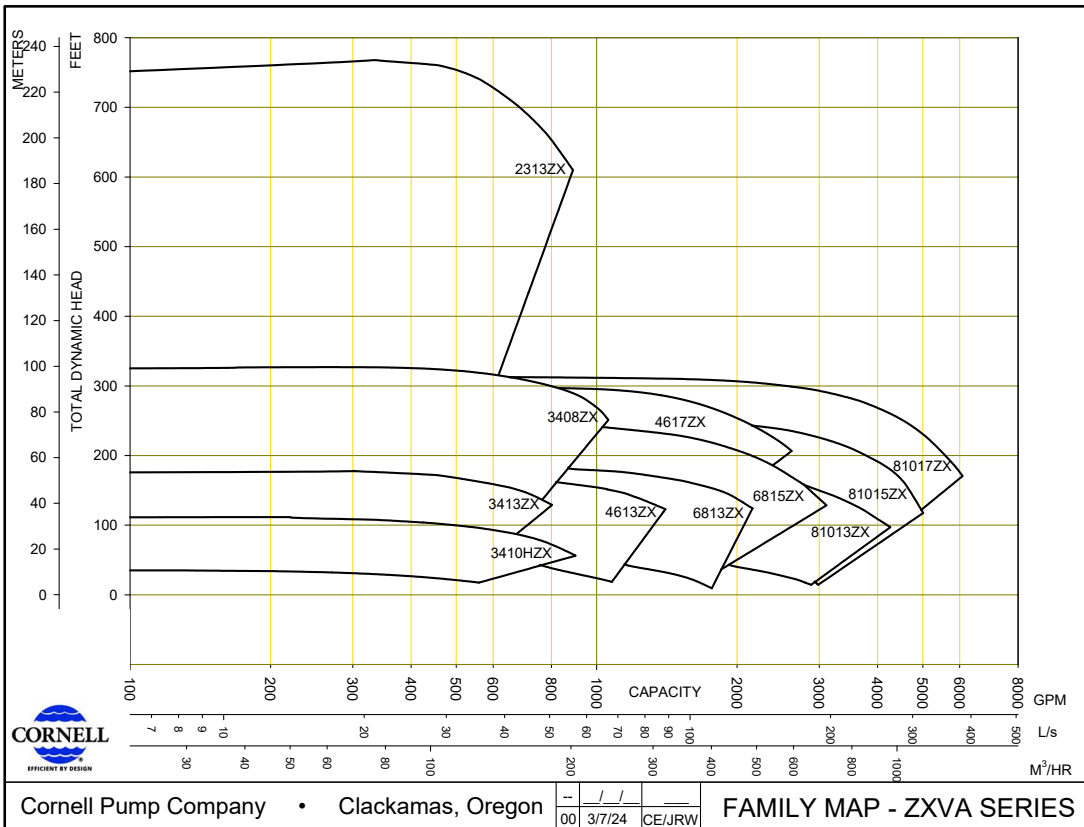
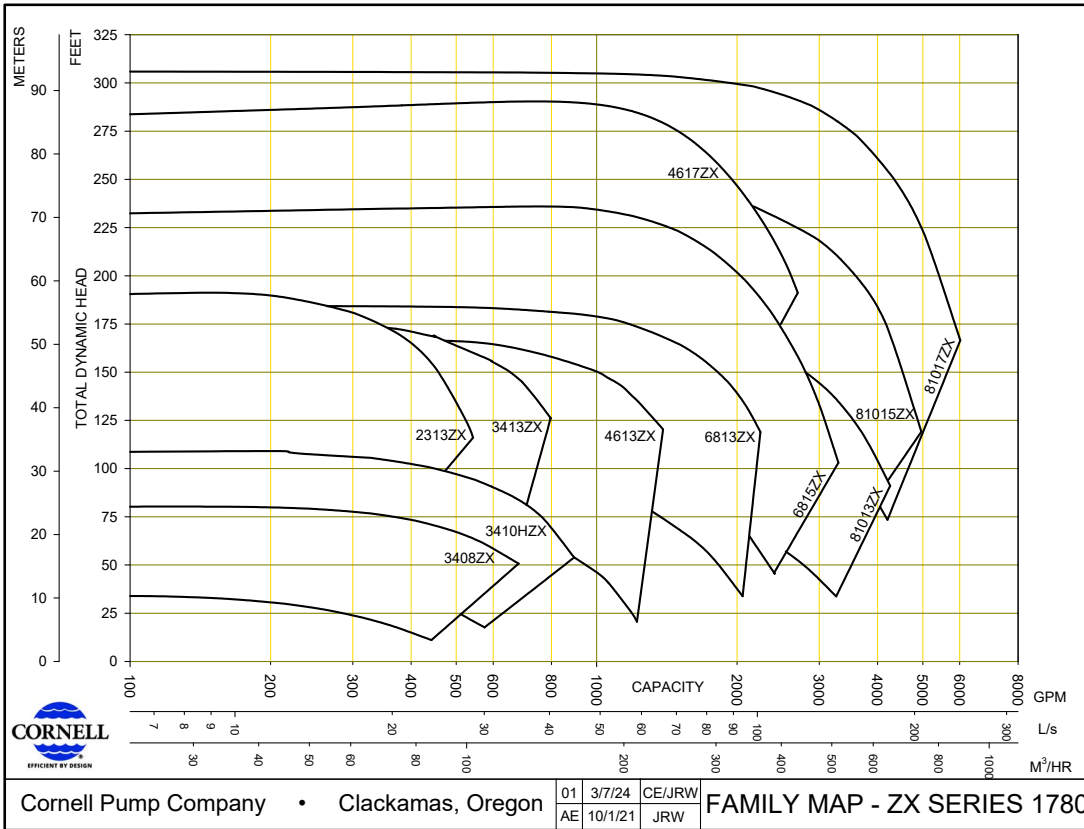

Z-SERIES PUMPS

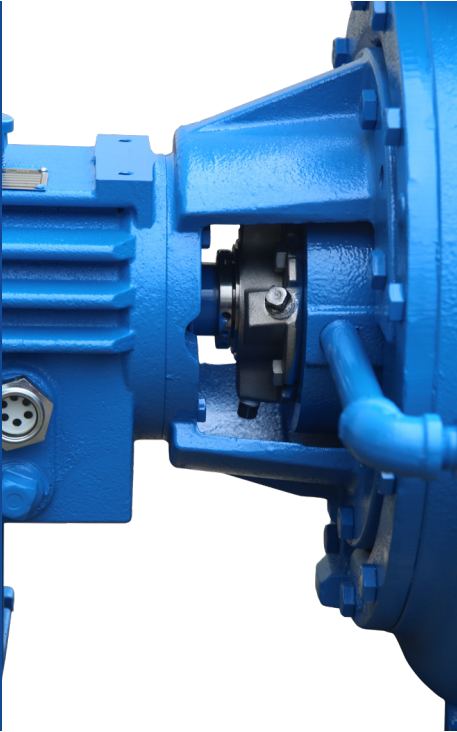

Z-SERIES PUMPS SPECIFICATIONS

PERFORMANCE	
DISCHARGE SIZE RANGE	2" TO 8"
MAX SOLIDS HANDLING	2.5"
MAX FLOW	5,000 GPM
MAX HEAD	750'

MATERIALS OF CONSTRUCTION

- Ductile Iron (DI) wet ends
- Cast iron bearing frames
- Shafts of carbon steel or stress proof steel
- Cast iron wear rings
- CD4MCu materials available
- Cartridge or Cycloseal®



WHY CD4MCu

CD4MCu is duplex stainless steel that uses a two-phase metallurgy process, different from the single-phase metallurgy process found in common stainless steel grades like 316. This process combines the corrosion resistance of 300-series stainless steel with the strength and hardness of 400-series stainless steel. This results in stainless steel with equivalent or superior corrosion resistance to 316 SS but with twice the yield strength. CD4MCu allows pumps to be used in more abrasive applications with enhanced resistance to corrosive cracking and pitting.

CD4MCu BENEFITS

- Corrosion and pitting resistance
- Higher strength than standard grades of stainless steel
- Improved ductility and weldability
- Better resistance to embrittlement

ANSI COMPATABILITY

Z-SERIES AND ANSI

WHAT IS AN ANSI PUMP?

ANSI is an acronym for the American National Standards Institute (ANSI). In 1974, ANSI established a B73.1 standard that specifies requirements for a single-stage end suction, horizontal, center-line discharge centrifugal pump. ANSI pumps must conform to a size envelope so they are dimensionally interchangeable between manufacturers meeting the standard.

ANSI B73.1 specifies that the pump design should include overall dimensions, centerline suction, discharge distance, and the height of the pump centerline. Other required specifications include self-ventilation, foot mountings, and back pullouts.

WHY Z SERIES IS BETTER:

Z-Series, designed by Cornell, the industry leader in efficiency and innovative design, is not just ANSI dimensionally compatible but also a reliable choice. Consider the difference between a cheap single-blade razor and a sleek multi-blade razor with refinements and features. Both may fit dimensionally in the same space, but their performance, longevity, and ease of use differ. Similarly, Z-Series ANSI pumps offer a level of reliability that sets them apart.

Points that differentiate the Z-Series include:

- Efficiency
- Robust Design
- Cost of ownership
- Competitive price
- Quality
- Innovative Design
- IoT
- Double Volute



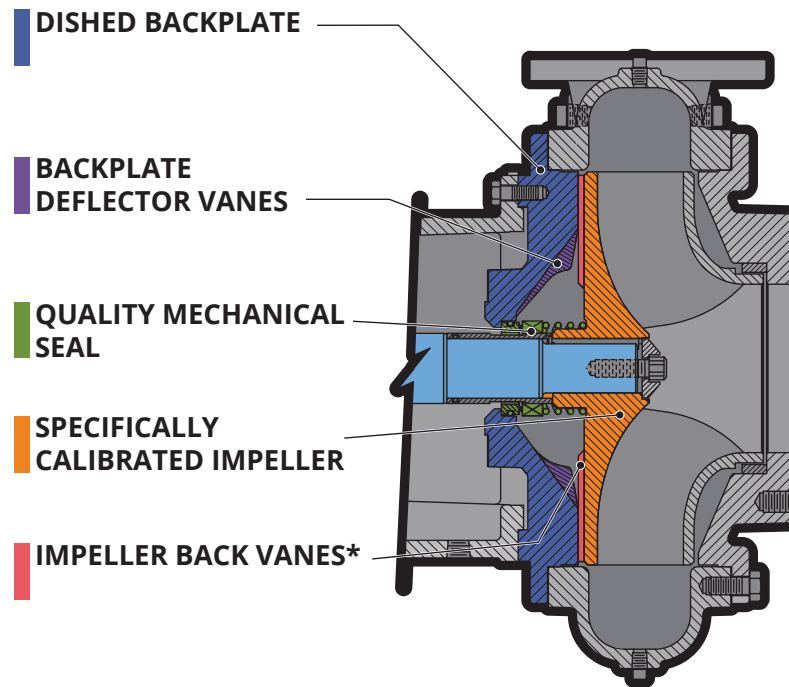

CYCLOSEAL® — THE SEALING SYSTEM INTEGRAL TO CORNELL PUMPS

Cornell's manure pumps come equipped with the patented Cycloseal sealing system, which leverages cyclonic action to extract solids and abrasive substances from the seal area while simultaneously purging air and gas pockets. This groundbreaking technology extends the lifespan of the seal and eliminates the requirement for venting or flushing water.

No Flush Water or Packing: Cycloseal technology eradicates the need for packing or flushing water with its backplate and wide vanes, leading to cost savings, less service time, and no messy drips.

Extended Seal Life: Cornell's Cycloseal is highly durable in harsh conditions such as manure slurry, starch recovery, clear water, food processing, and self-priming applications, with the potential to triple the expected seal lifespan.

Run-Dry™ Option: Cornell's Cycloseal system-equipped pumps have an optional Run-Dry feature that lubricates the seal faces even without liquid in the pump casing. The Run-Dry feature is indispensable in scenarios where the pump must operate dry for an extended duration or may lose prime unexpectedly without being turned off.

System Savings: Cycloseal system eliminates the need for external water flush, filters, grease cups, or piping typically found in pumps with packing or mechanical seals.

Better for Abrasive Applications: Cycloseal is more durable than packing and regular mechanical seals that come into contact with grit and other substances, as it prevents solids from entering the seal area, resulting in less seal wear.

Greater Reliability: With positive seating, end users can easily detect when the Cycloseal is correctly installed, leading to longer service intervals due to its increased ability to withstand grit.

Maintenance Savings: A more durable seal results in less pump downtime and lower maintenance expenses throughout the pump's lifespan.

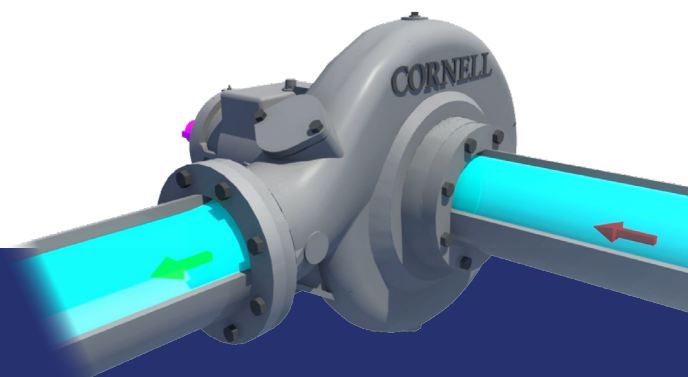

**Watch the Cycloseal® video
online to see it in action:**

<http://www.cornellpump.com/support/videos.html>

REDI-PRIME® & RUN DRY™

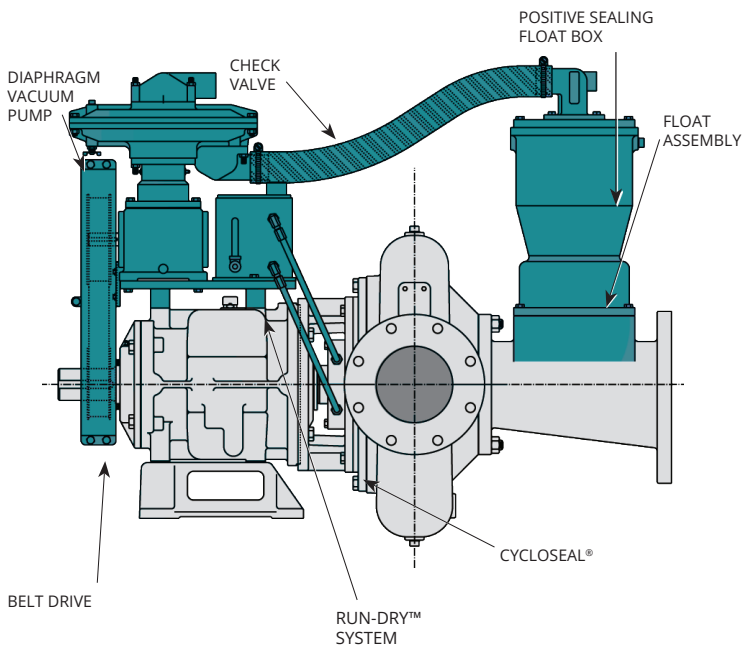

REDI-PRIME®

CORNELL'S REDI-PRIME SYSTEM is a patented technology that enables pumps to prime or re-prime themselves automatically without constant monitoring. With oversized suctions the Redi-Prime pumps provide greater flow, reduced friction losses, and higher suction lift. The system can handle large solids and air/liquid mixtures while maintaining premium hydraulic efficiency and lower energy consumption.

To ensure environmental safety, the Redi-Prime system utilizes a positive sealing float box and a diaphragm vacuum pump, which prevents any water carry-over that could contaminate the environment. The system can be easily installed on most Cornell pumps.

The Redi-Prime system offers the following benefits:

- Fully automatic priming and repriming
- Efficiently handles air/liquid mixtures
- Rapidly primes and re-primes completely unattended
- Environmentally safe priming system designed to prevent product leakage
- Premium hydraulic efficiency for reduced energy consumption

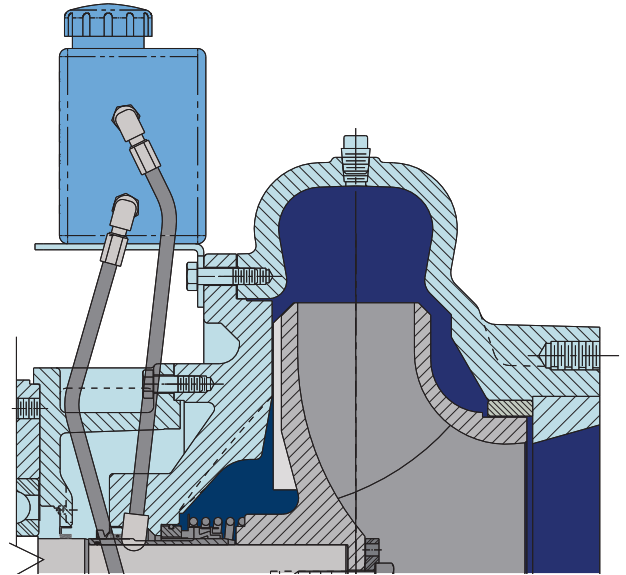

RUN-DRY™

CORNELL'S RUN-DRY™ SYSTEM offers a solution for applications where the pump may operate in a dry condition. The system comprises an auxiliary gland and oil reservoir that lubricates the seal faces and prevents dry running during priming, re-priming, or standby operation. The gland is connected to a lubricant reservoir through inlet and outlet lines to ensure continuous circulation and cooling of the lubricant and seal faces. The Run-Dry system allows your pump to run dry for extended periods without causing damage to the mechanical seal. It can be used with Cycloseal® and Redi-Prime® for optimal performance.

- Run dry for hours without damaging the seal
- Cools and lubricates seal faces
- Ideal for applications that could operate in a dry condition
- Useable in conjunction with Cycloseal® and Redi-Prime®



CORNELL CO-PILOT™



Connect via Cell Network



5 Sensor Inputs



Remote Control



CORNELL Co·Pilot™

THE POWER OF IOT

Cornell Co-Pilot is a monitoring system that connects to your pump to track temperature, vibration, and location. Co-Pilot can also be powered with a wired connection for continuous monitoring and control system integration. Our Internet of Things (IoT) platform reflects our dedication to cutting-edge design and meeting customer needs.

USE THE CO-PILOT TO:

- Plan maintenance
- Check operation
- Reduce manual inspections
- Track pump location
- Demonstrate run conditions to customers on warranty claims
- Improve run time through the maintenance program

MONITORING AT YOUR FINGER TIPS

Easily monitor your pump's performance with desktop and mobile apps available for iOS and Android. Receive alerts for out-of-condition operations and view the last GPS location of the pump, all in one convenient platform.

CORNELL CO-PILOT ALLOWS YOU TO:

- Monitor pumps using the cloud and IOT
- Monitor temperature, vibration, and GPS location
- Additionally monitor pressure, flow, start/stop operations, and more*
- Track data over time via web-based and mobile apps
- Receive real-time pump data for performance and health monitoring
- Receive alerts for preset running conditions

*Requires external sensors; contact Cornell for details.

PART OF RPM² ASSET
MANAGEMENT SYSTEM



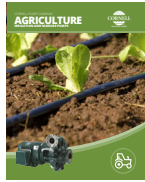

AGRICULTURE



FOOD PROCESS



INDUSTRIAL

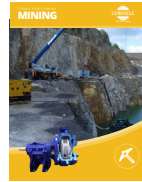

MINING



MUNICIPAL

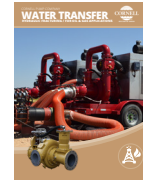

WATER TRANSFER



REFRIGERATION

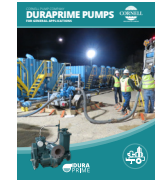

CONSTRUCTION

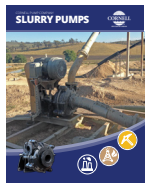

SLURRY

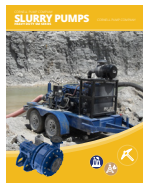

SLURRY SM



MANURE

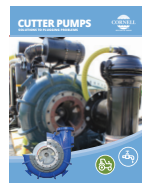

CUTTERS



SELF PRIMING

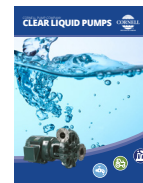

CLEAR LIQUIDS



MX SERIES

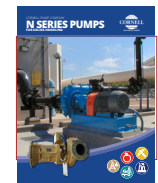

N SERIES

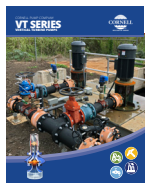

CYCLONE™

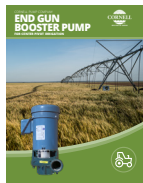

EDGE™



HYDRAULIC SUBS

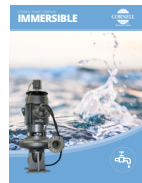

IMMERSIBLE



CD4MCU



RUN-DRY™



PRIMING SYSTEMS

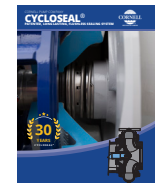

CYCLOSEAL®

Cycloseal® and Redi-Prime® are Registered Trademarks of Cornell Pump Company.

Cornell pumps and products are the subject of one or more of the following U.S. and foreign patents:

6,074,554; 6,036,434; 6,079,958; 6,309,169; 6,104,949.

24 - IN - BR - 101

CORNELLPUMP.COM
©2024 CORNELL PUMP COMPANY

AUTHORIZED CORNELL PUMP DISTRIBUTOR

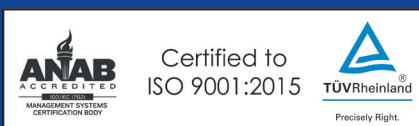

Cornell Pump Company
Clackamas, Oregon, USA
P: +1 (503) 653-0330
F: +1 (503) 653-0338