

CORNELL PUMP COMPANY

CO-PILOT™

FLOWMETER SKID

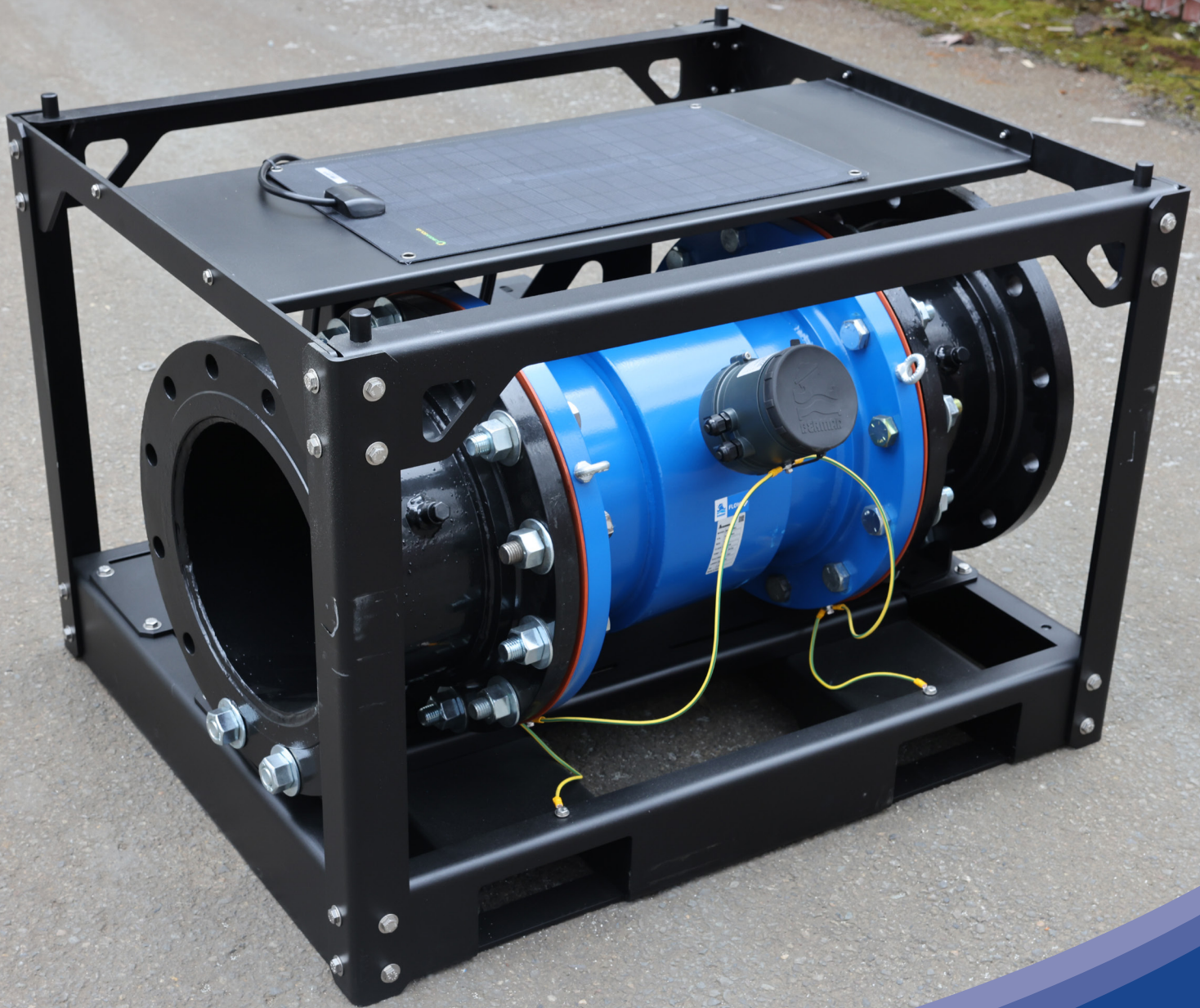

CORNELL 
Co·Pilot™
FLOWMETER SKID

CO-PILOT™ FLOWMETER SKID

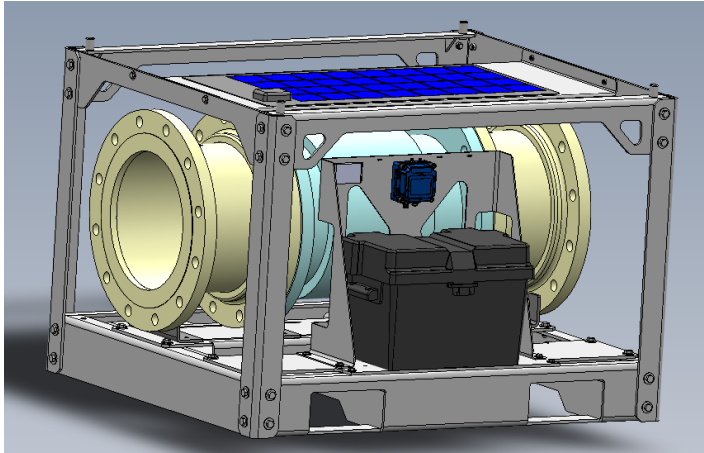

FLOW METER	
LINEAR MATERIALS	EBONITE
METERING TYPE	MAGNETIC
ELECTRODE MATERIAL	HASTELLOY C
FLANGE RATING	ANSI 150LB
INGRESS RATING	IP68 (HEAD UNIT)
BODY CONSTRUCTION	FULLY WELDED & INTERNALLY POTTED
VOLTAGE	BATTERY or 12-24VDC
AMBIENT TEMPERATURE	-4° TO 140°F / -20 TO 60°C
FLUID TEMPERATURE	-13° TO 176°F / -25° TO 80°C
ACCURACY	0.2% of rate +/-0.08in/sec
FLOW VELOCITY RANGE	0.05ft/sec TO 32.81ft/sec
FLOW UNITS	Ft3, GAL, m, m3, l, ML
OUTPUTS	PULSE , 4-20mA (when powered) MODBUS

ABOUT ELECTRIC SKID

Flowmeter Skid can operator autonomously in harsh, remote conditions, sending back information via cell service. No need to travel to isolated locations with this easy-to-configure and easy-to-monitor device.

FEATURES

- Remote flow meter data
- Self-sustaining unit
- Available in sizes 4"-12"
- Stack-able units
- Fork pockets and lifting eyelets

CO-PILOT SPECIFICATIONS

- 4 Analog Inputs
- 1 Digital Input
- 4G LTE on AT&T or Verizon
- Web browser or iOS/Android apps

ELECTRICAL SPECIFICATIONS

- Standard 12 VDC car battery
- 40 W solar panel
- Optimized charge controller

CORNELL 
Co·Pilot™

To learn more about Co-Pilot's monitoring capabilities, visit co-pilot.cornellpump.com

CO-PILOT™ FLOWMETER SKID

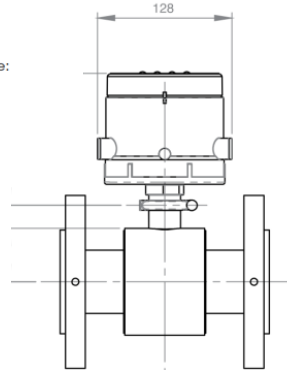
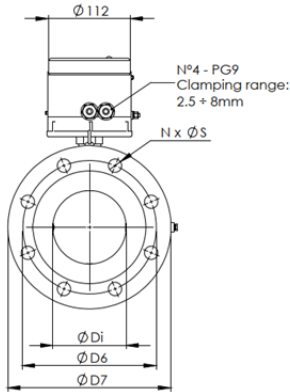
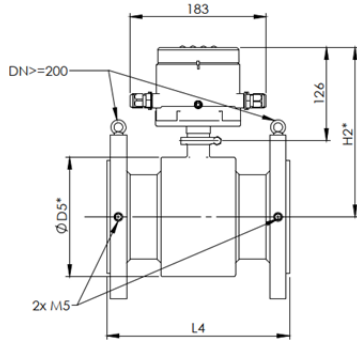

MECHANICAL INSTALLATION

The following mechanical installation images are designed to show how simple it is to set up a Cornell Co-Pilot Flow Meter. If an end-user has questions, Cornell offers calibration videos on our YouTube Channel for an easy setup. Cornell's inside application engineers also stand ready to answer any questions about Flow Meter installation, Co-Pilot, or other IIoT offerings.

SIZE	H (in)	H1 (in)
4"	3.19	19.08
6"	4.13	21.08
8"	5.16	23.25
10"	6.30	25.67
12"	7.32	27.83

DN	L4	DS	Di	D6	D7	N	S	H1	H2	H3
4"	9.84	6.34	3.83	7.50	9.06	8	3/4	9.19	9.00	10.81
6"	11.81	8.27	5.84	9.50	11.02	8	7/8	10.16	9.96	11.77
8"	13.78	10.28	7.68	11.75	13.58	8	7/8	11.16	10.96	12.78
10"	17.72	12.56	9.65	14.25	15.94	12	1	12.30	12.11	13.92
12"	19.69	14.61	12.12	17.00	19.09	12	1	13.33	13.13	14.94

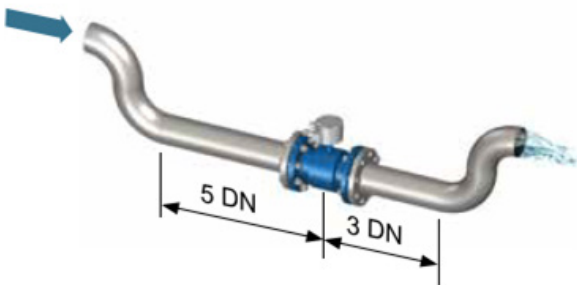

INSTALLATION GUIDELINES

IMPORTANT NOTE: THE SENSOR MUST ALWAYS BE FULL OF LIQUID

Flow Meter should be installed 5x pipe diameters downstream of any obstructions (pipe bends, valves, etc.) and 3x pipe diameters upstream of any obstructions.

AVOID NEGATIVE PRESSURE INSTALLATIONS

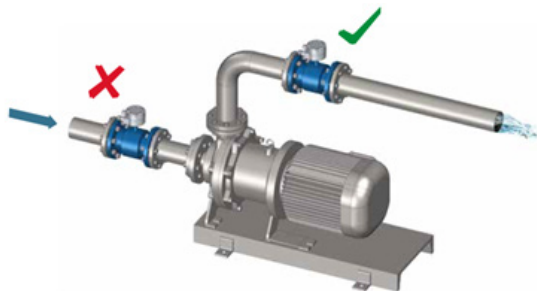

VIEW HELPFUL SETUP VIDEOS AT:

[HTTPS://WWW.YOUTUBE.COM/@CORNELLPUMPCOMPANY](https://www.youtube.com/@cornellpumpcompany)



AGRICULTURE



FOOD PROCESS



INDUSTRIAL



MINING



MUNICIPAL

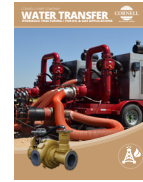

WATER TRANSFER



REFRIGERATION

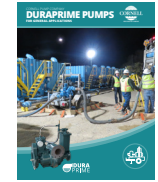

CONSTRUCTION

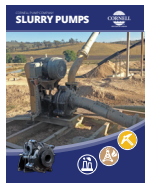

SLURRY

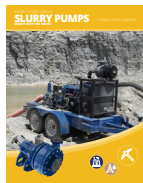

SLURRY SM



MANURE

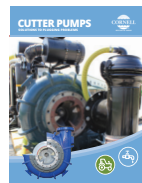

CUTTERS



SELF PRIMING

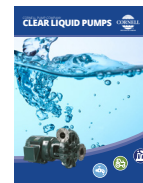

CLEAR LIQUIDS



MX SERIES

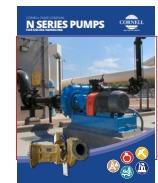

N SERIES

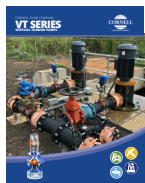

CYCLONE™

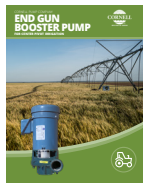

EDGE™



HYDRAULIC SUBS



IMMERSIBLE



CD4MCU



RUN-DRY™



PRIMING SYSTEMS

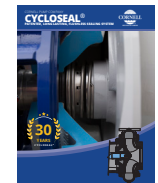

CYCLOSEAL®

Cyclo Seal® and Redi-Prime® are Registered Trademarks of Cornell Pump Company.

Cornell pumps and products are the subject of one or more of the following U.S. and foreign patents:

6,074,554; 6,036,434; 6,079,958; 6,309,169; 6,104,949.

24 - IO - BR - 401